

OPzV6-200(6V200Ah)



OPzV series is Valve Regulated Lead Acid battery that adopts immobilized GEL and Tubular Plate technology to offer high reliability and performance. The Battery is designed and manufactured according to DIN standards and with die-casting positive grid and patented formula of active material OPzV series exceeds DIN standard values with more than 18 years floating design life at 25 °C and It is the best solution for cyclic use under extreme operating conditions.



Specification

Cells Per Unit	3
Voltage Per Unit	2
Nominal Capacity	200Ah@10hr-rate to 1.80V per cell @25°C
Weight	Approx. 28.0Kg (Tolerance±3.0%)
Internal Resistance	Approx. 2.95 mΩ
Terminal	F14(M8)/F16(M8)
Max. Discharge Current	2000A (5 sec)
Design Life	18 years (floating charge)
Max. Charging Current	40.0 A
Reference Capacity	C3 157.0AH C5 176.0AH C10 200.0AH C20 214.2AH
Float Charging Voltage	6.80 V~6.90 V @ 25°C Temperature Compensation: -3mV/°C/Cell
Cycle Use Voltage	7.05 V~7.20 V @ 25°C Temperature Compensation: -4mV/°C/Cell
Operating Temperature Range	Discharge: -40°C~60°C Charge: -20°C~50°C Storage: -40°C~60°C
Normal Operating Temperature Range	25°C±5°C
Self Discharge	RITAR Valve Regulated Lead Acid (VRLA) batteries can be stored for up to 6 months at 25°C and then recharging is recommended. Monthly Self-discharge ratio is less than 2% at 20°C. Please charged batteries before using.
Container Material	A.B.S. UL94-HB, UL94-V0 Optional.

Dimensions

Unit: mm

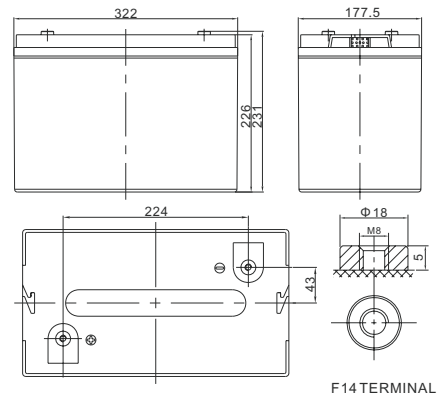

Length	322±2mm (12.7 inches)
Width	177.5±2mm (6.99 inches)
Height	226±2mm (8.90 inches)
Total Height	231±2mm (9.09 inches)
Torque Value	10~12 N*m

Constant Current Discharge Characteristics : A(25°C)

F.V/ Time	10min	15min	30min	1h	2h	3h	5h	8h	10h	20h
1.60V	327.3	262.7	173.9	119.8	74.20	57.51	37.81	25.46	21.40	11.24
1.65V	306.9	248.3	167.7	116.2	71.80	56.26	37.00	25.06	21.00	11.03
1.70V	280.6	231.4	160.3	112.3	69.40	54.39	36.20	24.66	20.60	10.82
1.75V	256.9	213.2	149.8	106.4	67.00	52.32	35.19	24.26	20.40	10.71
1.80V	223.9	190.7	139.2	100.0	63.80	50.03	33.99	23.66	20.00	10.50
1.85V	186.2	165.1	124.0	91.14	59.00	46.71	32.38	22.66	19.14	10.05

Constant Power Discharge Characteristics : WPC(25°C)

F.V/ Time	10min	15min	30min	1h	2h	3h	5h	8h	10h	20h
1.60V	513.4	426.0	319.6	227.0	141.8	110.7	73.60	50.33	42.20	22.16
1.65V	500.3	417.5	311.2	221.5	137.8	108.8	72.19	49.52	41.60	21.84
1.70V	474.8	401.2	300.5	215.6	134.0	105.5	70.79	48.92	41.00	21.53
1.75V	430.8	372.5	283.3	205.0	130.0	102.1	69.18	48.12	40.60	21.32
1.80V	370.6	337.6	265.8	193.6	124.2	97.57	66.77	46.92	39.80	20.90
1.85V	306.5	283.2	238.7	177.4	115.2	91.34	63.75	44.91	38.20	20.06

(Note) The above characteristics data are average values obtained within three charge/discharge cycle not the minimum values.

The battery must be fully charged before the capacity test. The C₁₀ should reach 95% after the first cycle and 100% after the third cycle.

OPzV6-200(6V200Ah)



Discharge Characteristics Curve

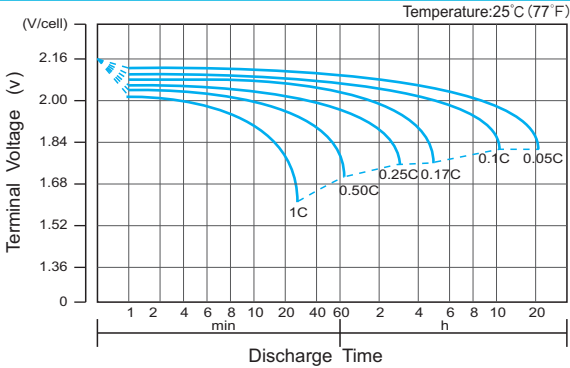

Charge Characteristic Curve for Cycle Use(IU)

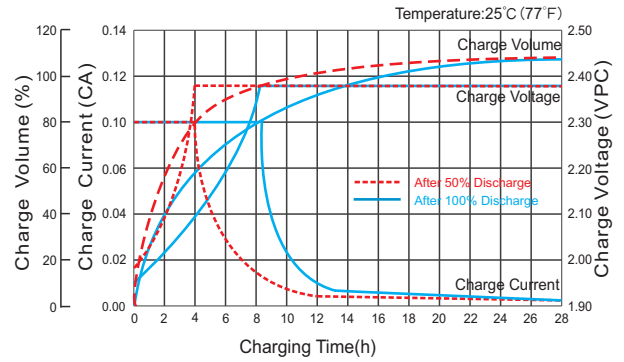

Cycle Life in Relation to Depth of Discharge

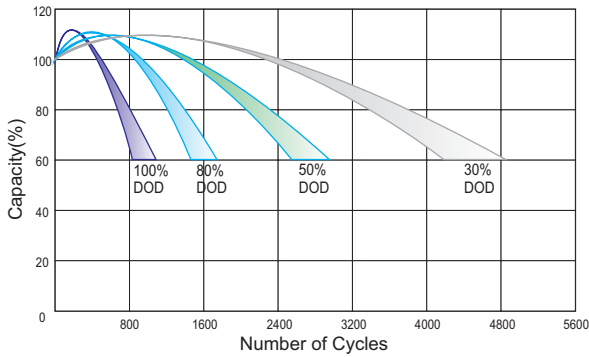

Relationship Between Charging Voltage and Temperature

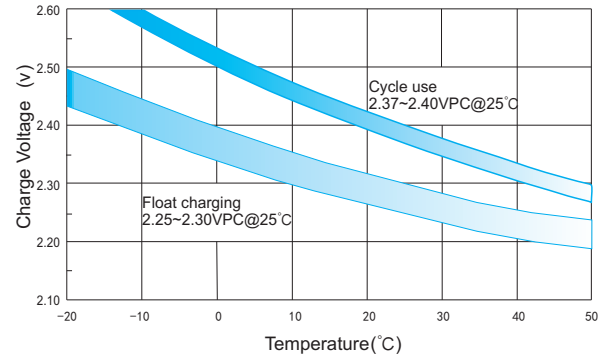

Temperature Effects on Capacity

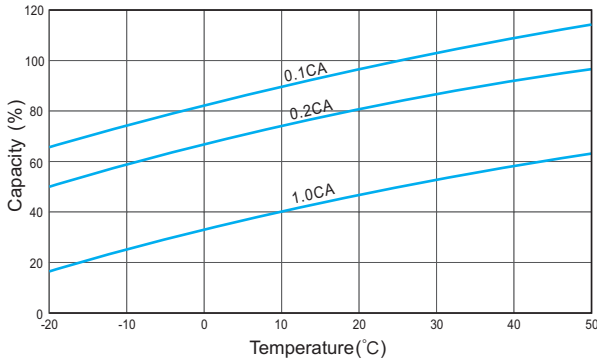

Storage Characteristics

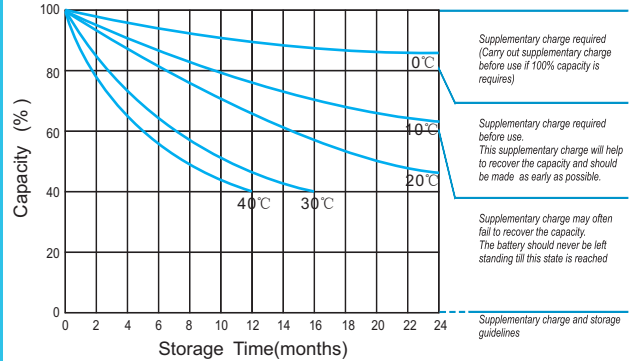

Effect of Temperature on Long Term Life

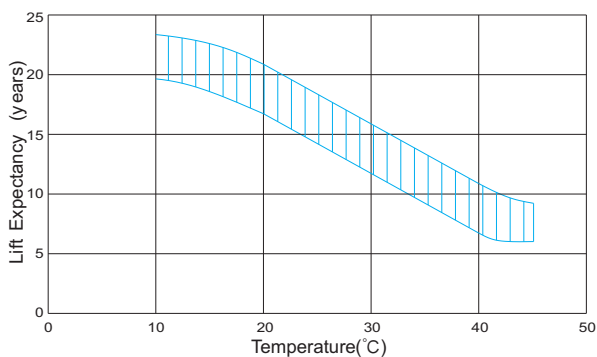

Relationship of OCV And State of Charge(20°C)

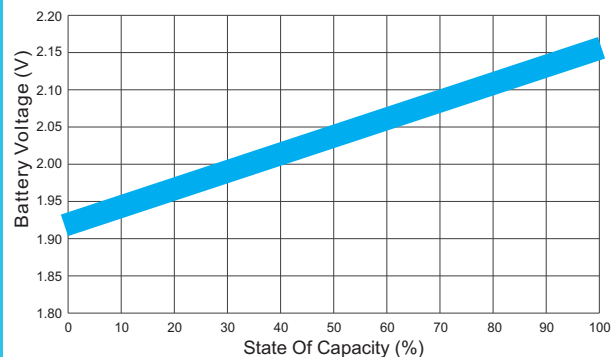

(Note) All above information shall be changed without prior notice, Ritar reserves the right to explain and update the latest information.