

# OPzS2-1500(2V1500Ah)



OPzS series is flooded Lead Acid battery that adopts Tubular Plate technology to offer high reliability and performance. The Battery is designed and manufactured according to standards and with DIN40736/IEC60896 positive spine and patent formula of die-casting active material. The OPzS series batteries offer 400% more cyclic life than the standby series. It is suitable for solar and wind renewable energy storage, traction etc. The OPzS series is the best choice of energy storage system in high altitude area.



## Specification

<b>Cells Per Unit</b>	1
<b>Voltage Per Unit</b>	2
<b>Nominal Capacity</b>	1500Ah@10hr-rate to 1.80V per cell @25°C
<b>Weight</b>	Without Electrolyte 83.5 kg/With Electrolyte 113.5kg
<b>Internal Resistance</b>	Approx. 0.21 mΩ
<b>Terminal</b>	F10(M8)
<b>Max. Discharge Current</b>	5000A (5 sec)
<b>Design Life</b>	20 years (floating charge)
<b>Max. Charging Current</b>	185 A
<b>Reference Capacity</b>	C3 1219.5AH C5 1357.5AH C10 1500.0AH C20 1815.6AH
<b>Float Charging Voltage</b>	2.23 V~2.25 V @ 25°C Temperature Compensation: -3mV/°C/Cell
<b>Cycle Use Voltage</b>	2.40 V~2.45 V @ 25°C Temperature Compensation: -4mV/°C/Cell
<b>Operating Temperature Range</b>	Discharge: -15°C~50°C Charge: 0°C~40°C Storage: -15°C~50°C
<b>Normal Operating Temperature Range</b>	25°C ± 5°C
<b>Self Discharge</b>	OPzS series is flooded Lead Acid battery . It can be stored for up to 2 years before filling acid. Monthly Self-discharge ratio is less than 3.5% at 20°C .Please charged batteries before using.
<b>Container Material</b>	SAN UL94-HB, UL94-V0 Optional.

## Dimensions

Unit: mm

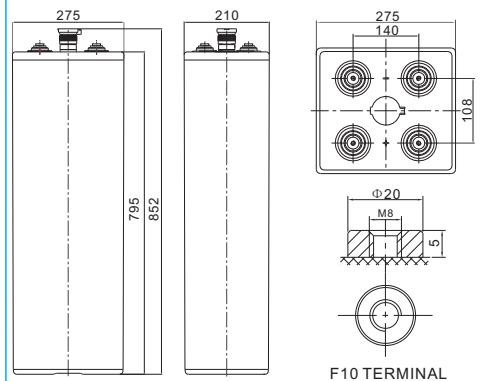

Length	275±2mm (10.8 inches)
Width	210±2mm (8.27 inches)
Height	795±2mm (31.3 inches)
Total Height	852±2mm (33.5 inches)
Torque Value	10~12 N*m

### Constant Current Discharge Characteristics :A(25°C)

F.V/ Time	30min	1h	2h	3h	4h	5h	6h	8h	10h	20h
1.60V	1583	1021	604.6	440.2	339.4	284.6	248.0	195.1	164.2	94.4
1.65V	1535	960.8	584.9	429.5	334.7	280.7	244.9	193.6	162.6	93.5
1.70V	1417	930.7	568.5	419.6	328.9	276.4	241.7	192.0	161.1	92.6
1.75V	1272	868.9	544.0	406.5	323.5	271.5	237.0	188.8	157.9	90.8
1.80V	1149	775.0	503.8	382.1	309.3	259.7	226.7	180.2	150.0	86.3
1.85V	957.8	664.3	450.6	346.8	285.5	240.1	210.1	168.4	140.5	80.8

### Constant Power Discharge Characteristics : WPC(25°C)

F.V/ Time	30min	1h	2h	3h	4h	5h	6h	8h	10h	20h
1.60V	2678	1741	1105	825.1	656.0	551.1	481.8	382.4	326.2	187.6
1.65V	2633	1668	1075	808.3	647.6	545.1	477.1	379.2	324.7	186.7
1.70V	2500	1651	1049	791.8	637.6	537.8	472.3	376.1	321.6	184.9
1.75V	2304	1580	1016	773.7	629.2	530.0	464.4	371.4	317.0	182.3
1.80V	2138	1447	953.4	733.4	603.2	508.5	446.3	357.2	304.0	174.8
1.85V	1833	1275	871.1	674.5	558.7	472.0	415.5	336.7	286.4	164.7

(Note) The above characteristics data are average values obtained within three charge/discharge cycle not the minimum values.

The battery must be fully charged before the capacity test. The C<sub>10</sub> should reach 95% after the first cycle and 100% after the third cycle.

# OPzS2-1500(2V1500Ah)



## Discharge Characteristics Curve

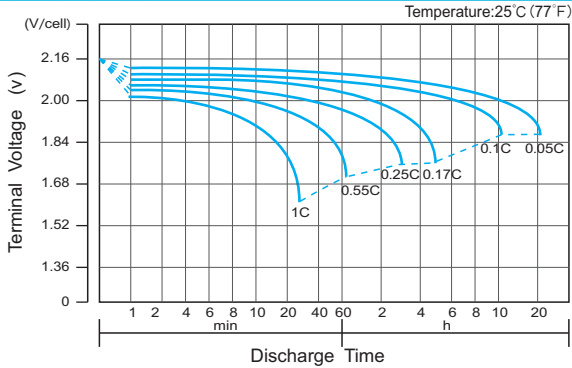

## Charge Characteristic Curve for Cycle Use(IU)

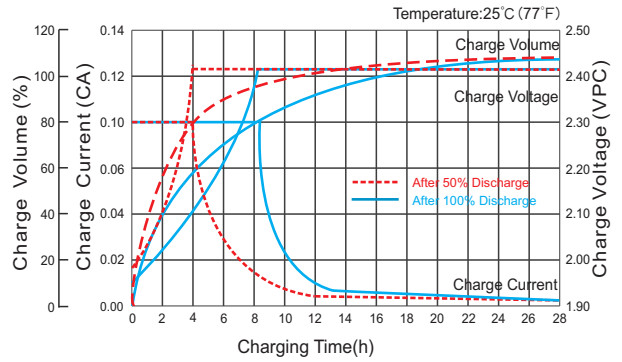

## Cycle Life in Relation to Depth of Discharge

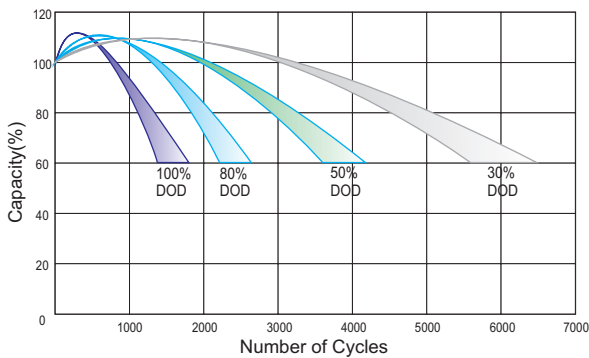

## Relationship Between Charging Voltage and Temperature

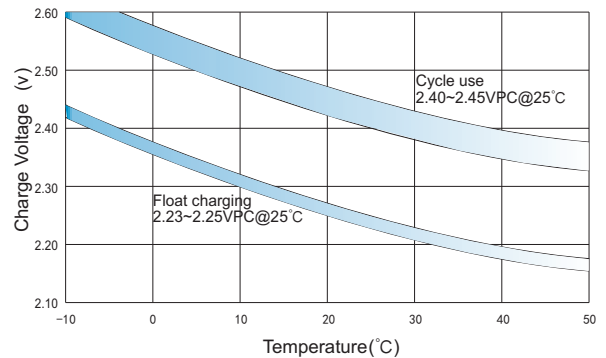

## Temperature Effects on Capacity

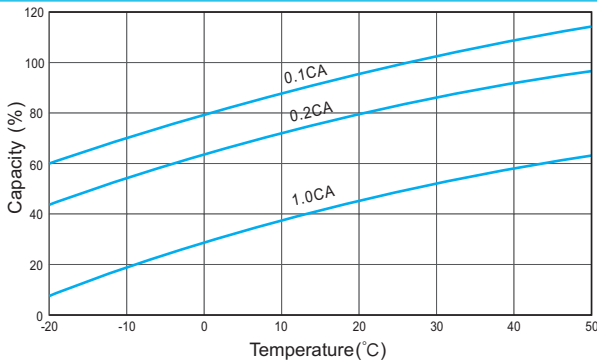

## Storage Characteristics

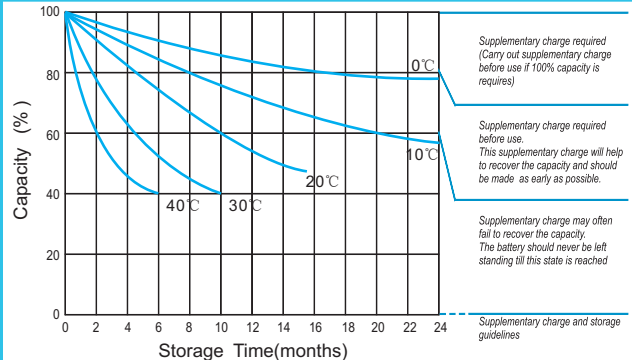

## Effect of Temperature on Long Term Life

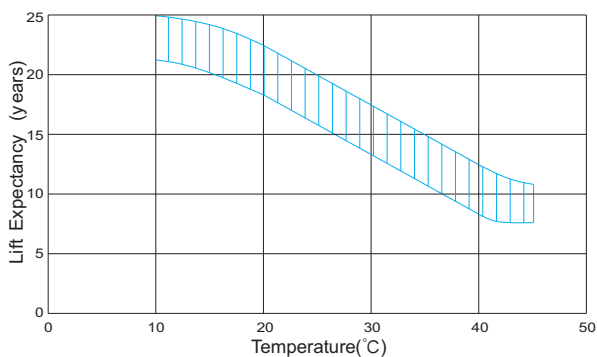

## Life Characteristics Of Standby Use

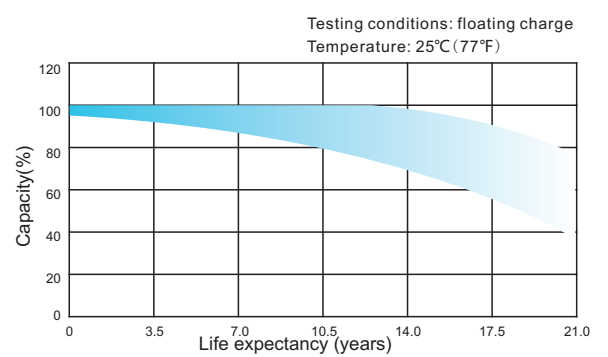

(Note) All above information shall be changed without prior notice, Ritar reserves the right to explain and update the latest information.