



RT 1270H (12V7.0Ah) (29.8w/cell)

RT1270H is high rate series with 5 years floating design life, especially designed for high rate load discharge applications. By using strong grid and specific paste plate to insure high performance during big current discharge requirement when electricity is off., High Rate series offering extra-durable stable performance under high rate discharge.



Specification

Cells Per Unit	6
Voltage Per Unit	12
Capacity	29.8W@15min-rate to 1.67V per cell @25°C
Weight	Approx. 2.2 Kg
Max. Discharge Current	70 A (5 sec)
Internal Resistance	Approx. 18 mΩ
Operating Temperature Range	Discharge: -20°C~60°C Charge: 0°C~50°C Storage: -20°C~60°C
Normal Operating Temperature Range	25°C±5°C
Float charging Voltage	13.7 to 13.9 VDC/unit Average at 25°C
Recommended Maximum Charging Current Limit	2.1 A
Equalization and Cycle Service	14.6 to 14.8 VDC/unit Average at 25°C
Self Discharge	RITAR Valve Regulated Lead Acid (VRLA) batteries can be stored for more than 6 months at 25°C. Self-discharge ratio less than 3% per month at 25°C. Please charge batteries before using.
Terminal	Faston tab 250(F1/F2)
Constainer Material	A.B.S. (UL94-HB), Flammability resistance of UL94-V2 can be available upon request.



MH28539



G4M20206-0910-E-16



ISO9001:2000 Certificate

Dimensions

Unit: mm Dimension: 151(L)×65(W)×93.5(H)

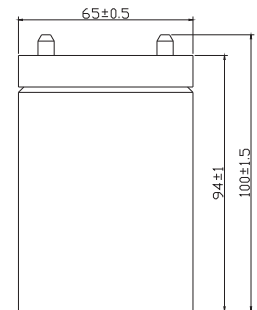
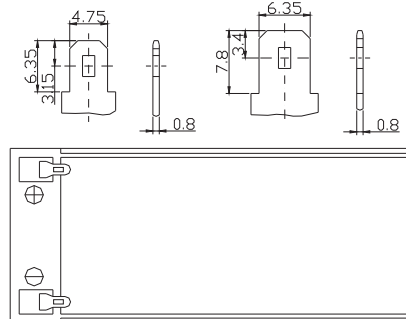
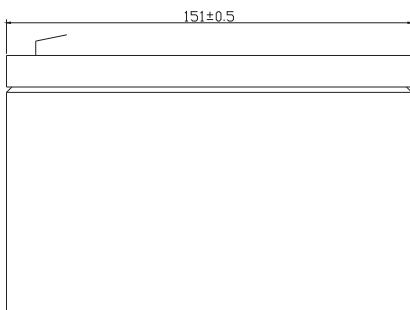

Constant Current Discharge Characteristics : A(25°C)

F.V/Time	5MIN	8MIN	10MIN	15MIN	20MIN	30MIN	60MIN	90MIN
9.60V	34.38	25.05	21.35	16.83	12.84	9.26	5.24	4.14
10.0V	32.10	23.73	20.27	16.17	12.07	8.89	5.01	3.95
10.2V	31.11	23.16	19.70	15.80	11.69	8.70	4.96	3.91
10.5V	30.09	21.69	18.52	15.18	11.45	8.49	4.80	3.80
10.8V	29.06	20.07	16.92	14.40	10.97	8.21	4.63	3.76
11.1V	26.83	18.64	15.15	13.76	10.67	7.16	4.45	3.64

Constant Power Discharge Characteristics : W(25°C)

F.V/Time	5MIN	8MIN	10MIN	15MIN	20MIN	30MIN	60MIN	90MIN
9.60V	368.4	271.2	232.2	183.3	140.2	101.3	57.26	45.37
10.0V	347.3	259.4	222.9	178.6	133.4	98.44	55.72	44.07
10.2V	340.0	253.8	216.9	175.4	130.4	96.90	55.24	43.59
10.5V	332.1	241.8	207.0	170.3	129.0	96.15	54.64	43.46
10.8V	323.8	226.8	192.6	165.0	125.8	94.34	53.68	43.28
11.1V	305.3	212.7	188.9	158.0	122.1	89.73	52.45	42.90

All mentioned values are average values.

RT1270H

12V7.0Ah



Effect of temperature on long term float life

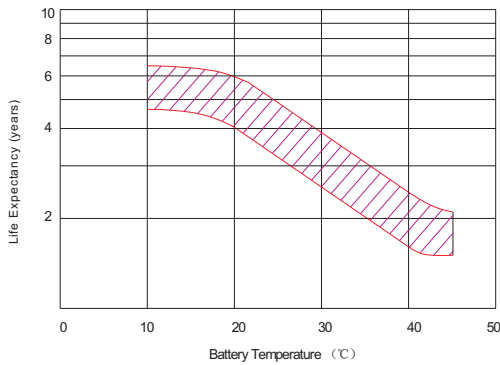

Storage characteristic

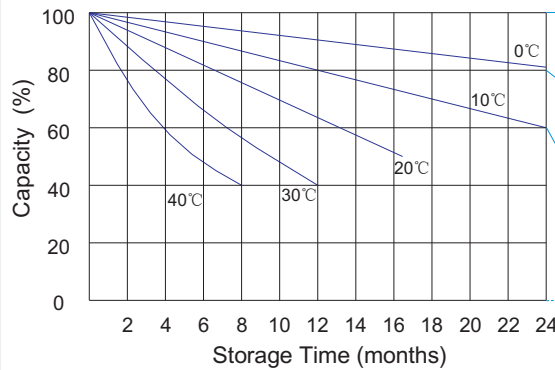

Supplementary charge required (Carry out supplementary charge before use if 100% capacity is required)

Supplementary charge required before use. This supplementary charge will help to recover the capacity and should be made as early as possible.

Supplementary charge may often fail to recover the capacity. The battery should never be left standing till this state is reached

Supplementary charge and storage guidelines

Charge characteristic Curve for standby use

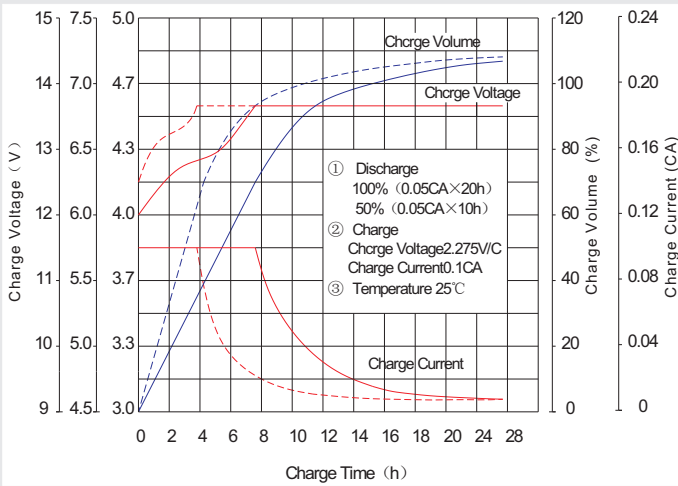

Discharge characteristic Curve

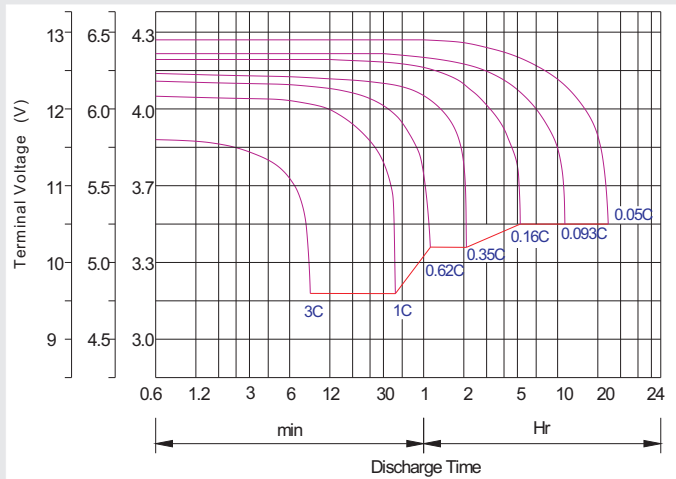

Capacity Factors With Different Temperature

Battery Type		-20°C	-10°C	0°C	5°C	10°C	20°C	25°C	30°C	40°C	45°C
GEL Battery	6V&12V	50%	70%	83%	85%	90%	98%	100%	102%	104%	105%
	2V	60%	75%	85%	88%	92%	99%	100%	103%	105%	106%
AGM Battery	6V&12V	46%	66%	76%	83%	90%	98%	100%	103%	107%	109%
	2V	55%	70%	80%	85%	92%	99%	100%	104%	108%	110%

Discharge Current VS. Discharge Voltage

Final Discharge Voltage V/cell	1.75V	1.70V	1.60V
Discharge Current (A)	(A) ≤ 0.2C	0.2C < (A) < 1.0C	(A) ≥ 1.0C

Maintenance & Cautions

Float Service:
※ Every month, recommend inspection every battery voltage.
※ Every three months, recommend equalization charge for one time.
Equalization charge method:
Discharge: 100% rate capacity discharge.
Charge: Max. current 0.3CA, constant voltage 2.4-2.45V/Cell charge 24h.
※ Effect of temperature on float charge voltage: -3mV/°C/Cell.
※ Length of service life will be directly affected by the number of discharge cycles, depth of discharge, ambient temperature and charging voltage.

Charge the batteries at least once every six months, if they are stored at 25°C.

Charging Method:

Constant Voltage	-0.2Cx2h + 2.4~2.5V/Cellx24h, Max. Current 0.3CA
Constant Current	-0.2Cx2h + 0.1CAx 12h
Fast	-0.2Cx2h + 0.3CAx4.0h