



RA12-33EV (12V33Ah)

RA12-33EV is specially designed for deep cycle discharge and grouping usage in electric vehicle application. By the special active material design in the plate, it makes battery have more than 300 cycles life time by 100% D.O.D. Specially, the consistency performance of grouping usage is much better than general series.



Specification

| | |
|--|---|
| Cells Per Unit | 6 |
| Voltage Per Unit | 12 |
| Capacity | 33Ah@10hr-rate to 1.75V per cell @25°C |
| Weight | Approx. 10.2 Kg |
| Max. Discharge Current | 330 A (5 sec) |
| Internal Resistance | Approx. 9 mΩ |
| Operating Temperature Range | Discharge: -20°C~60°C Charge: 0°C~50°C Storage: -20°C~60°C |
| Normal Operating Temperature Range | 25°C±5°C |
| Float charging Voltage | 13.6 to 13.8 VDC/unit Average at 25°C |
| Recommended Maximum Charging Current Limit | 9.9 A |
| Equalization and Cycle Service | 14.6 to 14.8 VDC/unit Average at 25°C |
| Self Discharge | RITAR Valve Regulated Lead Acid (VRLA) batteries can be stored for more than 6 months at 25°C. Self-discharge ratio less than 3% per month at 25°C. Please charge batteries before using. |
| Terminal | Terminal F7/F11 |
| Constainer Material | A.B.S. (UL94-HB), Flammability resistance of UL94-V2 can be available upon request. |



MH28539



G4M20206-0910-E-16



ISO9001:2000 Certificate

Dimensions

Unit: mm Dimension: 195(L)×130(W)×180(H)

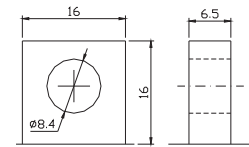
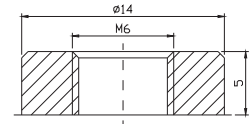
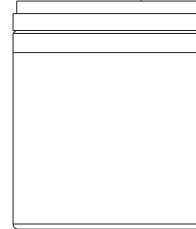
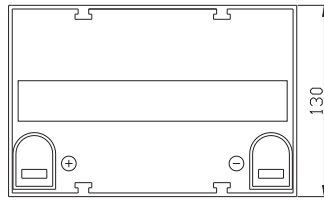
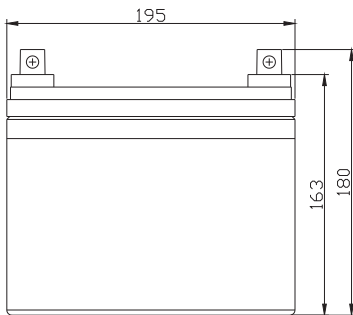

Constant Current Discharge Characteristics: A(25°C)

| F.V/Time | 5MIN | 10MIN | 15MIN | 30MIN | 1HR | 2HR | 3HR | 4HR | 5HR | 8HR | 10HR | 20HR |
|----------|--------|-------|-------|-------|-------|-------|-------|-------|-------|-------|-------|-------|
| 9.60V | 118.3 | 86.35 | 65.52 | 39.20 | 23.16 | 13.46 | 9.301 | 7.908 | 6.415 | 4.226 | 3.505 | 1.943 |
| 10.0V | 114.9 | 82.16 | 64.18 | 38.52 | 23.06 | 13.36 | 9.266 | 7.871 | 6.377 | 4.191 | 3.471 | 1.908 |
| 10.2V | 111.5 | 79.26 | 63.17 | 38.01 | 22.84 | 13.25 | 9.194 | 7.834 | 6.340 | 4.157 | 3.437 | 1.873 |
| 10.5V | 100.11 | 73.14 | 60.15 | 37.53 | 22.63 | 13.15 | 9.159 | 7.761 | 6.264 | 4.122 | 3.404 | 1.837 |
| 10.8V | 90.36 | 66.69 | 55.11 | 36.88 | 22.10 | 12.92 | 8.909 | 7.578 | 6.151 | 4.054 | 3.370 | 1.802 |
| 11.1V | 77.15 | 59.60 | 49.07 | 34.53 | 20.99 | 12.34 | 8.517 | 7.212 | 5.887 | 3.882 | 3.269 | 1.696 |

Constant Power Discharge Characteristics: W(25°C)

| F.V/Time | 5MIN | 10MIN | 15MIN | 30MIN | 1HR | 2HR | 3HR | 4HR | 5HR | 8HR | 10HR | 20HR |
|----------|-------|-------|-------|-------|-------|-------|--------|-------|-------|-------|-------|-------|
| 9.60V | 1237 | 919.6 | 720.8 | 443.8 | 267.7 | 158.6 | 110.69 | 94.26 | 76.53 | 50.45 | 41.88 | 23.30 |
| 10.0V | 1213 | 891.4 | 709.2 | 438.4 | 267.0 | 157.8 | 110.72 | 94.14 | 76.34 | 50.21 | 41.62 | 22.90 |
| 10.2V | 1199 | 867.9 | 701.2 | 434.3 | 265.0 | 156.8 | 110.24 | 93.93 | 76.08 | 49.88 | 41.25 | 22.47 |
| 10.5V | 1092 | 808.2 | 668.8 | 429.0 | 262.6 | 155.7 | 109.81 | 93.06 | 75.17 | 49.47 | 40.84 | 22.05 |
| 10.8V | 994.2 | 745.0 | 618.2 | 425.1 | 257.7 | 153.7 | 106.82 | 90.94 | 73.81 | 48.65 | 40.44 | 21.63 |
| 11.1V | 868.6 | 673.5 | 559.8 | 400.6 | 246.7 | 148.0 | 102.21 | 86.54 | 70.64 | 46.58 | 39.23 | 20.35 |

All mentioned values are average values.

RA12-33EV

12V33Ah



Life characteristics of cyclic use

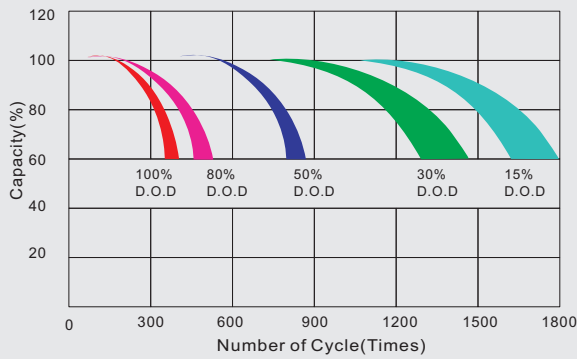

Storage characteristic



Charge characteristic Curve for standby use



Discharge characteristic Curve

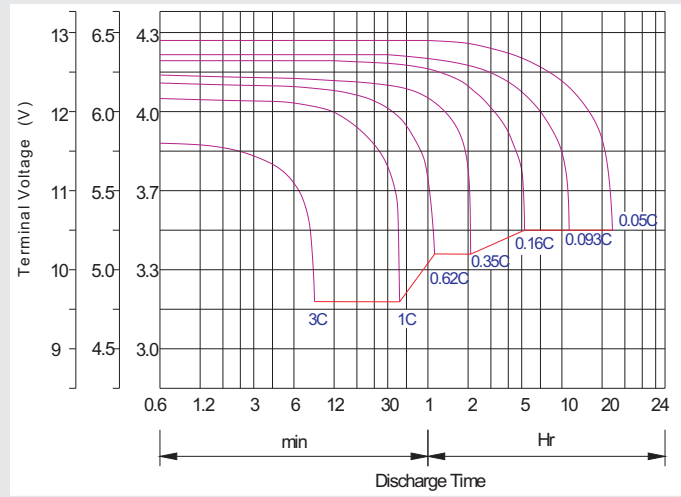

Capacity Factors With Different Temperature

| Battery Type | | -20°C | -10°C | 0°C | 5°C | 10°C | 20°C | 25°C | 30°C | 40°C | 45°C |
|--------------|--------|-------|-------|-----|-----|------|------|------|------|------|------|
| GEL Battery | 6V&12V | 50% | 70% | 83% | 85% | 90% | 98% | 100% | 102% | 104% | 105% |
| | 2V | 60% | 75% | 85% | 88% | 92% | 99% | 100% | 103% | 105% | 106% |
| AGM Battery | 6V&12V | 46% | 66% | 76% | 83% | 90% | 98% | 100% | 103% | 107% | 109% |
| | 2V | 55% | 70% | 80% | 85% | 92% | 99% | 100% | 104% | 108% | 110% |

Discharge Current VS. Discharge Voltage

| | | | |
|--------------------------------|------------|-------------------|------------|
| Final Discharge Voltage V/cell | 1.75V | 1.70V | 1.60V |
| Discharge Current (A) | (A) ≤ 0.2C | 0.2C < (A) < 1.0C | (A) ≥ 1.0C |

Maintenance & Cautions

Cycle service

- ※ Avoid battery over discharge, especially battery series connection use.
- ※ Charged with recommend voltage, ensure battery can be full recharged.
- In general, recharge capacity should be 1.1-1.15 times discharge capacity.
- ※ Effect of temperature on cycle charge voltage: -4mV/°C/Cell.
- ※ There are a number of factors that will affect the length of cyclic service.
- The most significant are depth of discharge, ambient temperature, discharge rate, and the manner in which the battery is recharged.
- Generally speaking, the most important factors is depth of discharge.

Charge the batteries at least once every six months, if they are stored at 25°C.

Charging Method:

| | |
|------------------|---|
| Constant Voltage | -0.2Cx2h+2.4~2.45V/Cellx24h, Max. Current 0.3CA |
| Constant Current | -0.2Cx2h+0.1CAx12h |
| Fast | -0.2Cx2h+0.3CAx4.0h |