



OPzV2-350 (2V350Ah)

Ritar OPzV series is a Valve Regulated Lead Acid battery that adopts immobilized GEL and Tubular Plate technology to offer high reliability and performance. The Battery is designed and manufactured according to DIN standards and with die-casting positive grid and patent formula of active material. OPzV series exceeds DIN standard values with more than 20 years floating design life at 25°C and is even more suitable for cyclic use under extreme operating conditions.



Specification

Voltage Per Unit	2V(single cell)
Capacity	350Ah@10hr-rate to 1.80V per cell @25°C
Weight	Approx. 27.5 Kg
Max. Discharge Current	1500 A (5 sec)
Internal Resistance	Approx. 0.80 mΩ
Operating Temperature Range	Discharge: -40°C~70°C Charge: 0°C~50°C Storage: -20°C~60°C
Optimal Operating Temperature Range	25°C ± 5°C
Float charging Voltage	2.25 to 2.3 VDC/unit Average at 25°C
Maximum Charging Current	70 A
Cycle Service	2.37 to 2.40 VDC/unit Average at 25°C
Self Discharge	Self-discharge ratio less than 2% per month at 25°C. Please charge batteries before using.
Terminal	Thread insert & Bolt (F10-M8)
Container Material	A.B.S. (UL94-HB), and UL94-V0 is optional



Dimensions

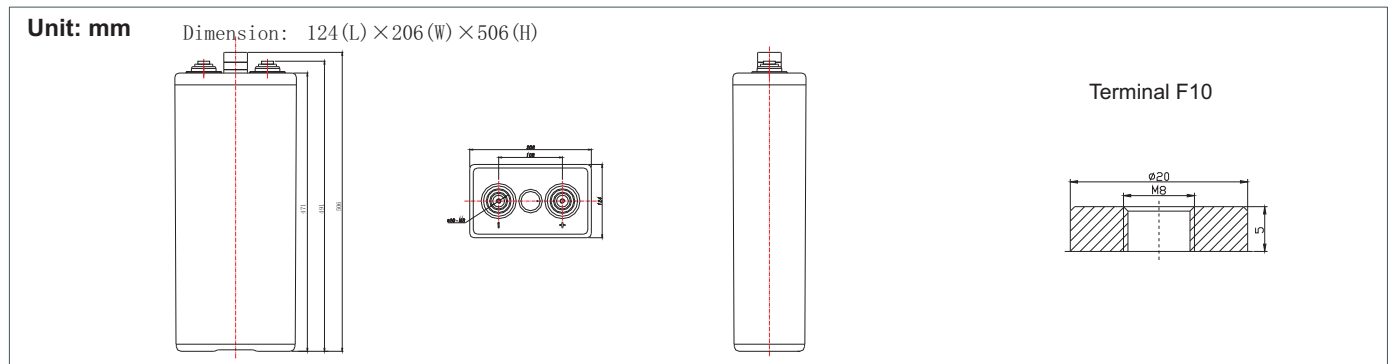

Constant Current Discharge Characteristics : A(25°C)

F.V/ Time	30min	1h	2h	3h	4h	5h	6h	8h	10h	20h
1.90	172.2	136.5	96.25	72.99	59.85	51.72	46.55	36.33	31.15	16.35
1.87	192.5	150.5	103.3	77.41	63.18	54.40	49.35	38.02	32.55	17.09
1.83	220.5	168.0	112.0	82.50	66.50	56.75	51.10	39.72	33.95	17.82
1.80	245.0	182.0	116.2	84.88	67.83	58.10	52.50	40.74	35.00	18.38
1.75	273.0	195.0	121.5	88.27	68.95	59.50	53.55	41.42	35.70	18.74
1.70	301.0	201.3	125.0	89.97	70.16	60.20	54.25	41.76	36.05	18.93
1.65	310.5	213.9	129.2	92.40	71.16	60.90	54.95	42.10	36.40	19.11
1.60	323.8	221.2	134.1	96.25	73.15	61.95	55.65	42.44	36.75	19.29

Constant Power Discharge Characteristics : W(25°C)

F.V/ Time	30min	1h	2h	3h	4h	5h	6h	8h	10h	20h
1.90	329.6	262.1	186.1	141.4	117.1	101.9	92.05	72.65	63.49	33.33
1.87	362.7	284.6	197.3	148.1	123.5	106.8	97.30	75.71	66.20	34.76
1.83	406.3	310.2	210.0	155.8	129.4	111.0	100.45	78.42	68.58	36.00
1.80	443.9	331.0	217.0	159.3	131.9	113.4	102.90	80.12	70.28	36.90
1.75	481.5	345.8	224.1	164.3	133.7	116.2	104.65	81.14	71.30	37.43
1.70	516.4	349.3	229.7	167.1	135.8	117.3	105.70	81.82	71.97	37.79
1.65	525.2	364.8	236.0	170.6	137.5	118.3	106.75	82.50	72.31	37.96
1.60	531.5	376.0	241.7	176.2	141.1	119.4	107.45	82.84	72.65	38.14

All mentioned values are average values.

OPzV2-350

2V350Ah



Effect of temperature on long term float life

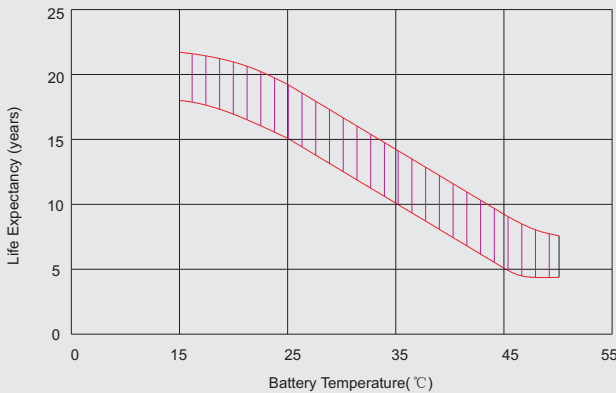

Life characteristics of cyclic use

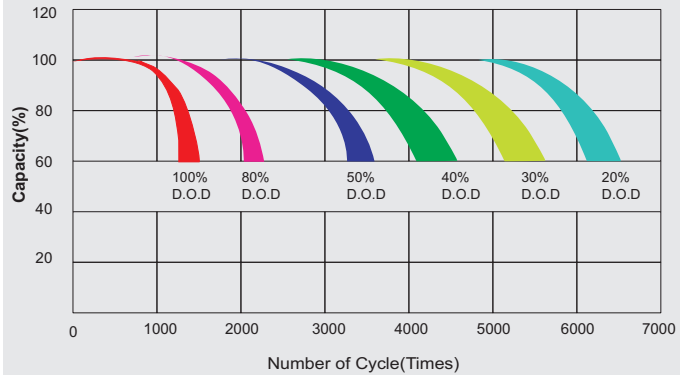

Charge characteristic Curve for cyclic use

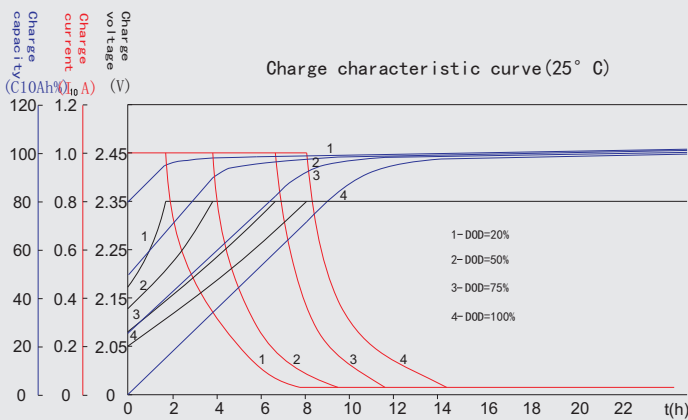

Discharge characteristic Curve

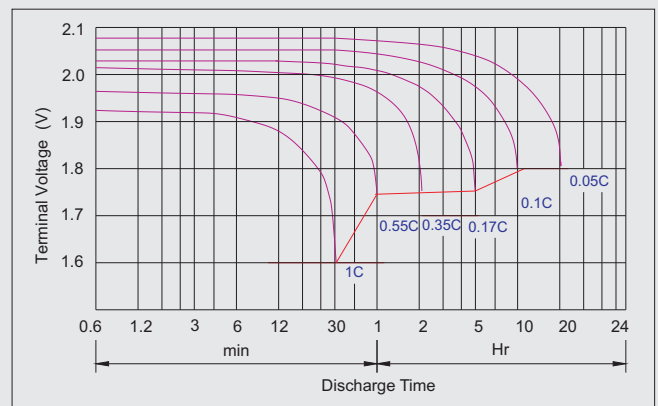

Long time discharge capacity for solar/wind application

Model	Capacity	C24 (Ah)	C48 (Ah)	C72 (Ah)	C100 (Ah)	C120 (Ah)	C240 (Ah)
		F.V=1.85VPC					
OPzV2-350		393	437	440	448	457	465

Capacity factors vs temperature (OPzV series)

Temperature	-30°C	-20°C	-10°C	0°C	10°C	20°C	25°C	30°C	40°C	45°C	50°C
Capacity	60%	75%	83%	89%	92%	99%	100%	103%	105%	107%	109%

Discharge Current VS. Final Voltage

Discharge current	Final voltage (V)
$I_{dis} \leq 0.1I_{10}$	1.90
$0.1I_{10} < I_{dis} \leq I_{10}$	1.85
$I_{10} < I_{dis} \leq 4I_{10}$	1.80
$4I_{10} < I_{dis} \leq 6I_{10}$	1.75
$6I_{10} < I_{dis} \leq 10I_{10}$	1.70
$I_{dis} > 15I_{10}$	1.60

Charge the batteries at least once every one year, if they are stored at 25°C.

Charging Method:

Constant Voltage	-0.2Cx2h+2.35~2.40V,24h,Max. Current 0.2CA
Constant Current	-0.2Cx2h+0.1CAx12h

Maintenance & Cautions

Float Service:

※ Every month, recommend inspection every battery voltage.

※ Every three months, recommend equalization charge for one time.

Equalization charge method:

Discharge: 40~50% rate capacity discharge.

Charge: Max. current 0.2CA, constant voltage 2.35-2.40V/Cell charge 24h.

※ Effect of temperature on float charge voltage: -3mV/°C/Cell.

※ Service life will be directly affected by the number of discharge

cycles, depth of discharge, ambient temperature and charging method.